



Certification Teaching Notes



Torch-applied Roof System Safety CERTA Program



NRCA

National Roofing Contractors
Association
10255 W. Higgins Road, Suite 600
Rosemont, IL 60018-5607
(847) 299-9070
Fax: (847) 299-1183
Email: nrca@nrca.net
nrca.net



Midwest Roofing Contractors
Association
2077 Embury Park Road
Dayton, OH 45414
Toll Free: (800) 497-6722
Fax: (937) 278-0317
Email: info@mrca.org
mrca.org

©2023 by the National Roofing Contractors Association and Midwest Roofing Contractors Association
All rights reserved
Printed in the United States of America

No part of this publication may be reproduced or distributed in any form or by any means or stored in a database or retrieval system without prior written permission of the publishers.

CERTA Program
Torch-applied Roof System Safety

Certification Teaching Notes

PROGRAM INTRODUCTION

SECTION INTRODUCTION

OUTCOME Upon completion of this introductory unit, participants will be able to:

1. Explain the importance of CERTA training

TIMING This unit is divided into three parts:

- A. CERTA Introduction (15 minutes)
- B. Icebreaker (10 minutes)
- C. Welcome (10 minutes)

Total Unit Time: 35 minutes

MATERIALS

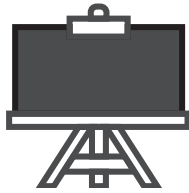

Flip chart and markers



Student manuals



FACILITATION GUIDE

Sec.	Notes and Materials	Directions and Discussion
A	CERTA Introduction (15 minutes)	
		<p>Welcome participants to the class with enthusiasm.</p> <p>Introduce the CERTA program by explaining successful trainees will be certified as Certified Roofing Torch Applicators.</p> <p>Explain this certification might be necessary numerous reasons, but one could be for contractors to be insured because the insurance industry has suffered large losses from fires started by roofing torches.</p> <p>Most injuries and property damage can be avoided with proper safety precautions.</p> <p>Several insurance companies, building owners and some municipalities require roofing companies that perform torch work to have their roofing workers certified through this training program.</p> <p>Explain the following about their certification:</p> <ul style="list-style-type: none"> • An identification card will be issued to each participant. • The card will be valid for three years. • The card can be revoked at any time if a certified worker is observed performing unsafe work practices. • Additional training and testing will be required at the end of the three-year period to maintain certification. <p>Review briefly the list of safety practices found on page 2 (Spanish page 2) of their student manuals. Use your copy of this list on page 4.</p> <p>Do not take time now to discuss or explain details about these safety practices. You will address all of them throughout the class time.</p>
B	Icebreaker (10 minutes)	
		<p>Ask participants to line up in order of their birthdays, starting with Jan. 1 at one end and Dec. 31 at the other, somewhere in the room. Once they're lined up, ask them to get into groups of three starting from the January end of the line.</p> <p>Direct groups to brainstorm things they have in common. At the end of five minutes ask each group to name the most unique commonality.</p>

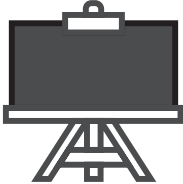
Sec.	Notes and Materials	Directions and Discussion
C	<p>Welcome (10 minutes) <i>Before starting the session, write the workshop outcomes on flip-chart paper and post them in the front of the classroom.</i></p>	
		<p>Before taking your first break, welcome participants to the seminar, and emphasize the importance of their active participation in the training.</p> <p>Introduce yourself and provide your credentials and related industry experience.</p> <p>Provide the following administrative details:</p> <ul style="list-style-type: none"> • Review the overall workshop outcomes listed on the flip chart. • Provide a site description including safety information, locations of restrooms and refreshments. • Explain the daily start and stop times. • Explain your break schedule and policies, including lunch breaks. • Describe the lunch arrangements. • Instruct all class members to turn off their pagers and cell phones or put them on vibrate mode. • Explain to participants that to become certified, they must pass a final written exam and a torching performance test during the hands-on section of the program. <p>Explain that to get the most out of the training session, students should:</p> <ul style="list-style-type: none"> • Ask questions • Share experiences that relate to topics • Request examples • Arrange an oral exam at a later date if they think they may have difficulties completing a written exam

CERTA Safety Practices for Roofing Torch Use

1 . CHECKLIST

1.1 Complete a daily checklist (job hazard analysis) for all torching jobs.

2. PRE-JOB PLANNING

2.1. The roofing contractor responsible for a project that involves the use of roofing torches must develop a written fire prevention plan identifying hazards and controls that the contractor plans to implement to reduce the risk of fire. Part of the plan must include:

2.1.1 The job foreman or supervisor shall review daily with the building owner conditions that could present hazards during torching and address them.

2.1.2 The contractor must identify hazards and establish controls to reduce or eliminate possible fire traps and hidden hazards; see Section 3, Application, paragraphs 3.1 – 3.2.4.2.2.

2.2 Have a minimum of two 4A60BC fire extinguishers available within 10 feet of each lit torch being used to heat membrane.

2.2.1 Train all personnel on the roof on how to use a fire extinguisher.

2.3 Inspect penetrations, such as exhaust vents, inside and outside. Lint, grease or other substances, if present, shall be cleaned prior to torching work.

2.4 Have a cell phone available or other means of immediately communicating with 911 or another emergency responder.

2.5 Comply with state and local fire and building ordinances where applicable.

3. APPLICATION

3.1 Field-of-the-roof installation

3.1.1 Over concrete, steel or gypsum roof decks:

3.1.1.1 The CERTA program recommends compliance with the recommendations contained in the most current edition of The NRCA Roofing Manual: Membrane Roof Systems. (See CERTA Authorized Trainers Guide Appendix for specific citations.)

3.1.2 Over plywood, wood plank, oriented strand board or wood fiberboard roof decks or substrates:

3.1.2.1 For compliance with CERTA Torching Principles, in no case may torch-applied membranes be applied by torching directly to the above-listed decks, including where a gypsum cover board has been installed.

3.1.2.2 In conjunction with the recommendation in the most current edition of The NRCA Roofing Manual: Membrane Roof Systems, the CERTA program does not recommend torching of modified bitumen products over plywood, wood plank, oriented strand board or wood fiber roof decks. Roofing contractors are advised to urge designers to consider alternative application specifications when polymer-modified bitumen roof membranes are specified over the above-listed decks.

3.1.2.3 On a project where a building owner or designer is unwilling to accept, or cannot change to, an alternative application specification, the CERTA program suggests the following to minimize the fire risk prior to application of polymer-modified bitumen field membranes:

3.1.2.3.1 Installation of a minimum 2-inch-thick stone wool insulation or min. ½ Portland cement or min. ½ inch gypsum deck board (e.g., DensDeck or Securock) fastened to the deck, followed by

3.1.2.3.2 Installation of an air-impermeable backer layer consisting of one of the following two options:

3.1.2.3.2.1 Option 1: Installation of a minimum of one layer of self-adhering, smooth-surfaced polymer-modified bitumen sheet.

3.1.2.3.2.2 Option 2: Installation of a layer of fiberglass ply sheet, fiberglass base sheet or polymer-modified bitumen base sheet mechanically fastened to the substrate and

3.1.2.3.2.1.1 Installation of a minimum of one additional layer of a fiberglass ply sheet adhered to the underlying layer in a solid mopping of hot asphalt, OR

3.1.2.3.2.1.2 Installation of a polymer-modified bitumen base sheet adhered to the underlying layer in a solid mopping of hot asphalt.

3.1.2.4 Roofing contractors should note that manufacturers' instructions or project specifications that do not meet the recommendations in 3.1.2.2 or 3.1.2.3 over decks specified in 3.1.2. are not addressed by of compliant with CERTA Torching Principles for fire-risk minimization.

3.2 Flashing installation: The CERTA program recommends polymer-modified bitumen flashings shall be installed using one of the following flashing system application methods:

3.2.1 Torch-and-flop indirect torching

3.2.2 Cold-applied adhesives

3.2.3 Mop-applied with hot bitumen

3.2.4 Direct torching using a single-burner, low-output (105k Btu or less) "detail" torch as follows:

3.2.4.1 Over plywood, wood plank, oriented strand board or wood fiberboard substrates or deck, an air-impermeable backer layer with sealed laps installed over the flashing and deck substrate shall be incorporated into the flashing assembly prior to the application of the torch-applied polymer-modified bitumen sheet finish surface. Acceptable adhered backer layers include ONE of the following:

3.2.4.1.1 Installation of:

3.2.4.1.1.1 A layer of fiberglass ply sheet, fiberglass base sheet or polymer-modified bitumen base sheet mechanically fastened to the substrate AND

3.2.4.1.2.1 An additional layer of a minimum of one-layer fiberglass ply sheet or polymer-modified bitumen base sheet adhered to the underlying layer in a solid mopping of hot asphalt.

3.2.4.1.2 Installation of a minimum of one layer of self-adhering, smooth-surfaced polymer-modified bitumen sheet.

3.2.4.2 Over concrete, masonry, steel, concrete block or gypsum substrates, an adhered backer layer with sealed laps installed over the flashing substrate shall be made part of the membrane flashing assembly prior to the application of the torch-applied polymer-modified bitumen sheet finish surface. Acceptable adhered backer plies include one of the following:

3.2.4.2.1 Installation of a minimum of one-layer of fiberglass ply sheet, fiberglass base sheet or polymer-modified bitumen base sheet adhered in a solid mopping of hot asphalt.

3.2.4.2.2 Installation of a minimum of one layer of self-adhering, smooth-surfaced polymer-modified bitumen sheet.

Note: If the membrane flashing substrate cannot be specifically identified as concrete, masonry, steel, concrete block or gypsum, direct torching with a detail torch is permitted if 3.2.4.1 is used.

4. TORCHING SAFETY

4.1 Only CERTA certified torch applicators shall operate torches when an open flame will contact any part of a roof.

4.1.1 Using an open flame for roof drying or de-icing shall be performed by CERTA certified torch applicators.

4.1.2 The use of an open flame torch solely to heat bitumen equipment valves (i.e., hot luggers, felt layers or kettles) or bitumen pipe assemblies is acceptable and may be performed by a noncertified applicator as long as an open flame does not contact the roof, flashings or any part of the roof assembly.

4.2 Never torch directly to any combustible material. Identify and protect materials that may burn when in contact with an open flame, such as, plywood, oriented strand board (OSB), wood, plank wood fiberboard and other combustible building components.

4.3 Never torch directly to an area where you cannot see the path of the open flame (including—but not limited to—flashings, corners, curbs, voids, expansion joints and small roof penetrations). Use alternative application methods, such as torch-and-flop indirect torching, cold-applied adhesives or mop-applied with hot bitumen, in these areas.

4.4 A lit torch shall only be placed on the roof surface, with the flame positioned in a safety direction, using a functional torch stand.

4.5 A lit torch shall never be left unattended.

5. FIRE WATCH REQUIREMENTS

5.1 There must be an ongoing job site fire watch conducted by a properly trained and dedicated individual. This includes:

5.1.1 During the entirety of lunch and other breaks when torching activity has been suspended

5.1.2 After all roofing torches have been shut down at the end of the workday.

5.1.2.1 A minimum two-hour fire watch, as described in the CERTA training program, shall be conducted and must include checking the roof's underside (whenever possible), as well as the roof surface, curbs and other flashings for smoldering or elevated temperatures

¹ combustible, i.e., plywood, OSB, wood plank or wood fiberboard

² noncombustible, i.e., concrete, masonry, concrete block or gypsum

Section
1

GENERAL REQUIREMENTS

SECTION INTRODUCTION

OUTCOMES Upon completion of this section, participants will be able to:

1. List personal protective equipment requirements for torching activities
2. Describe basic first-aid procedures associated with torching activities
3. Describe the PASS system for using a fire extinguisher

TIMING This section is divided into two parts:

- A. Video and discussion (20 minutes)
- B. Tic-tac-toe Review Exercise (10 minutes)

Total Unit Time: 30 minutes

MATERIALS





Video clip from CERTA training video
(Video introduction plus Part 1 running time is 7 minutes 32 seconds on the English video and 8 minutes 33 seconds on the Spanish.)



Student manuals

FACILITATION GUIDE

Sec.	Notes and Materials	Directions and Discussion
A	Video and Discussion (15 minutes)	
	<div style="display: flex; flex-direction: column; align-items: center; gap: 20px;">   </div>	<p>Show the Introduction and Part 1 of the DVD</p> <p>Ask the students what PPE should be used for torch work.</p> <p>Expected answers:</p> <ul style="list-style-type: none"> • Long-sleeved shirt, buttoned at neck and cuffs • Long pants without cuffs • Ankle-high boots • Hard hat (if overhead hazard) • Leather gloves with snug cuffs • Goggles or face shield <p>Ask the students what they <u>should not</u> do to a burn victim.</p>

		<p>Expected answers:</p> <ul style="list-style-type: none"> • Try to remove bitumen or clothing that is stuck to a burn. • Apply lotions, antiseptics or salves. <p>Ask the students what they should do to aid a burn victim.</p> <p>Expected answers:</p> <ul style="list-style-type: none"> • Call an ambulance. • Submerge the burn area in cool water. • Move the person out of the sun, if possible. <p>Direct the students to turn to page 12 (Spanish page 13) of their student manuals and review the classes of fires and types of fire extinguishers used for each (shown on student manual page 13 [Spanish page 14]).</p> <p>Tell the students the No. 1 rule if there is a fire is: ALWAYS CALL THE FIRE DEPARTMENT.</p> <p>Also, be certain you are not endangering yourself by attempting to put out a fire.</p> <p>Direct the students to turn to page 10 (Spanish page 11) of their student manuals and review the PASS system for using a fire extinguisher.</p> <p>Direct the students to turn to pages 8 and 9 (Spanish page 10) of their student manuals and review the fire extinguisher guidelines together as a class.</p> <p>Explain contact with propane may cause frostbite or freeze burns in exposed tissues.</p> <p>Direct the students to turn to pages 6-7 (Spanish page 8) of their student manuals and have them look over the first-aid recommendations for freeze burn.</p> <p>Ask the class how these recommendations differ from those for normal burns.</p> <p>Expected answers:</p> <ul style="list-style-type: none"> • The victim should be put in a warm area. • Immerse the burn area in neutral-temperature water. • Give the victim warm liquids to drink.
--	--	--

B Tic-tac-toe Review Exercise (10 minutes)

		<p>Refer the class to page 15 (Spanish page 16) of their student manuals to find the handout titled “Fire Safety Tic-tac-toe.”</p> <p>Ask the class to work in pairs and take five minutes to play the tick-tack-toe game.</p> <p>Explain they should flip a coin to see who starts the game and then play the game in the usual manner—except they may only place an X or O in a space if they can answer the question and the other person agrees the answer is correct.</p> <p>Stress they should be good sports while they play.</p> <p>Review the answers with the class when time is up by asking for volunteers to provide each answer. Be sure to allow opportunity for discussion and clarification if necessary. Your answer sheet is on the next page.</p>
---	--	---

FIRE SAFETY TICK-TACK-TOE

ANSWER SHEET

Fill in the blank:

A minimum of _____
4A60BC fire
extinguishers should be
readily available within
10 feet of all
torching activities.

ANSWER

Two

What does the plastic
seal band through the
release pin of a fire
extinguisher ensure?

ANSWER

*The plastic seal ensures
the fire extinguisher has
not been discharged.*

Name one thing you
should do
and
one thing you
should not do
when tending to a
burn victim.

ANSWER

*See the list on **pages 8 and 9**
of the student manual.*

Name two things that
should be done for
victims of propane
freeze burn.

ANSWER

*See the list on **page 9** of
the student manual.*

What words does the
term PASS stand for?

ANSWERS

*Pull
Aim
Squeeze
Sweep*

Name two materials that—
if they were on fire—
would be classified as
Class A fires.

ANSWERS

*Wood
Paper
Plastic
Rags*

Name three types of PPE
that should be used while
doing torch work.

ANSWERS

*Long-sleeved shirt
Cuffless pants
Leather gloves
Gauntlets
Goggles
Face shield
Ankle-high boots
Hard hat (if overhead hazard)*

What classification of
fire extinguisher should
be within 10 feet of
torch work?

ANSWER

4A60BC

What should be done with
a fire extinguisher that
has been discharged?

ANSWER

*Remove it from the job site,
and have it serviced by an
approved service provider.*

Section 2 PRE-JOB PLANNING AND PREPARATION

SECTION INTRODUCTION

- OUTCOMES** Upon completion of this section, participants will be able to:
1. Identify the key elements of a comprehensive pre-job inspection
 2. Prescribe hazard controls when torching near hazardous areas

- TIMING** This section is divided into two parts:
- A. Video and discussion (15 minutes)
 - B. Job-site hazards and controls review exercise (15 minutes)

Total Unit Time: 30 minutes

MATERIALS



Video clip from CERTA training video (running time 3 minutes 42 seconds on the English video and 4 minutes 34 seconds on the Spanish)



Flip chart and markers







Student manuals



Samples of:

- $\frac{3}{8}$ -inch-thick perlite, $\frac{3}{8}$ -inch-thick fiberglass and $\frac{1}{4}$ -inch-thick gypsum roof board insulation materials
- Fiberglass base sheets
- Fiberglass ply sheets
- Self-adhering polymer-modified bitumen base sheet

FACILITATION GUIDE

Sec.	Notes and Materials	Directions and Discussion
A	Video and Discussion (15 minutes)	
		<p>Show Part 2 of the video.</p>
	 	<p>Remind the class the video said daily inspections should be performed by a foreman or supervisor before work begins.</p> <p>Ask the class to name some of the hazards the inspector should be looking for, and record the answers on the flip chart.</p> <p>Expected answers:</p> <ul style="list-style-type: none"> • Confirm workers have proper PPE. • Make sure the crew knows the local fire codes and follows the rules. • Make note of flammable materials near work areas. • Make sure necessary fall protection is in place. • Other examples from video <p>Direct the students to turn to the Appendix of their student manuals and find the Daily Inspection Checklist.</p> <p>Point out the fact the Daily Inspection Checklist includes sections for in-progress inspections and post-job inspections and tasks, as well as pre-job inspections.</p> <p>Direct the students to turn to the section titled Identifying Hazards and Preventive Measures on page 16 (Spanish page 17) of their student manuals.</p> <p>Point out the fact the checklist names hazards and their possible controls, and explain in more detail the items on the checklist.</p> <p>Point out the organization of the list of hazards and controls in the student manual. For example, the list has general headings, such as General Working Conditions, and subheadings, such as Housekeeping and Fall Protection.</p>
B	Job-site Hazards and Controls Review (15 minutes)	
	  <p><i>Refer to the Job-site Hazards and Controls Matching Answer Sheet on the next page to review the exercise.</i></p>	<p>Ask participants to work in pairs to conduct the review exercise, and tell them they will have five minutes to complete the exercise.</p> <p>Explain they should refer to the lists of hazards and preventive measures for <u>pre-job inspections</u> found on pages 16-21 (Spanish pages 17-23) of their student manuals to find a “control” that matches the listed hazard, and then they should mark the corresponding letter on the line.</p> <p>Point out that the category of hazard (heading or subheading) is shown in italics above the description of the hazard on the handout.</p> <p>Review the sheet when time is up by asking students to volunteer to give the answer for each question. While reviewing each question, have the students turn to the related page in their student manuals that shows each hazard/control and briefly discuss each situation.</p> <p>Pass out samples of thermal barrier insulation materials, fiberglass base sheets, self-adhering polymer-modified bitumen base sheet and fiberglass ply sheets when you review these topics in the matching exercise.</p>

JOB-SITE HAZARDS AND CONTROLS

(Match each hazard to its control)

ANSWER SHEET

HAZARDS	CONTROLS
<p><i>General Working Conditions</i></p> <p><u> C </u> Loose materials can blow into torch flames.</p>	<p>A. Closest telephone access should be identified and communicated to all crew members.</p>
<p><i>Weather Conditions</i></p> <p><u> F </u> Wind conditions may cause open flames from torching equipment to extend beyond normal visibility.</p>	<p>B. If above-deck thermal insulation is NOT present over the roof deck, incorporate a thermal barrier into the roof system. Note: NRCA does not recommend torching over a combustible deck; additionally, a base ply alone does not qualify as a thermal barrier. (See Safety Practices on page 2 [Spanish page 2] of the student manual [page 4 in this instructors guide].)</p>
<p><i>Weather Conditions</i></p> <p><u> D </u> Bright sunlight limits open-flame visibility.</p>	<p>C. Remove all trash and debris from the workplace.</p>
<p><i>Specific Job-site Hazards</i></p> <p><u> G </u> Combustible flashing substrates are present.</p>	<p>D. Increase the distance of open flames to hazardous areas when flames cannot readily be seen.</p>
<p><i>Specific Job-site Hazards</i></p> <p><u> H </u> Rooftop penetrations are present.</p>	<p>E. Consult the building owner to identify and gain access to concealed attics and crawl spaces to fulfill regular daily inspections.</p>
<p><i>Specific Job-site Hazards</i></p> <p><u> B </u> A combustible roof deck is present.</p>	<p>F. Cease torching operations if spread of flames cannot be controlled.</p>
<p><i>Specific Job-site Hazards</i></p> <p><u> E </u> Concealed attics or crawl spaces are present immediately below a combustible deck.</p>	<p>G. If combustible flashing substrates are present, including cant strips, a two-layer backer should be incorporated into the flashing detail design and installation. Note: If the deck itself is combustible, NRCA does not recommend torching to it.</p>
<p><i>Emergency Communications</i></p> <p><u> A </u> It may be difficult to contact the local fire or emergency services department in the event of a fire.</p>	<p>H. Direct open flames should not contact any rooftop penetration.</p>

Section 3 PROPANE TOOL AND EQUIPMENT SAFETY

SECTION INTRODUCTION

OUTCOMES Upon completion of this section, participants will be able to:

1. Name the components of a roofing torch assembly
2. Explain the proper steps and procedures for handling propane gas cylinders

TIMING This section is divided into three parts:

- A. Video and discussion (15 minutes)
- B. Demonstration of roofing torch assembly (15 minutes)
- C. Propane cylinder discussion (15 minutes)

Total Unit Time: 45 minutes

MATERIALS



Video clip from CERTA training video
(running time is 4 minutes 02 seconds on the English video and
4 minutes 46 seconds on the Spanish)



Roofing torch assembly





Student manuals

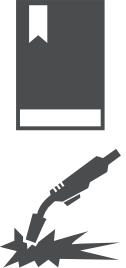

Flip chart and markers

FACILITATION GUIDE

Sec.	Notes and Materials	Directions and Discussion
A	Video and Discussion (15 minutes)	
		<p>Show Part 3 of the video.</p> <p>Ask the participants what they think is the most important information presented in Part 3 of the video.</p> <p>If individuals have not stated <u>why</u> they think certain information is important, ask them to provide their reasons.</p>
B	Demonstration of Roofing Torch Assembly (15 minutes)	
		<p>Show the class the roofing torch assembly.</p> <p>Point out the components of the torch and assembly that are shown in Figure 1 on page 22 (Spanish page 24) of the student manuals and ask the class to name the parts.</p> <p>Direct the students to turn to Photo 2 (picture of a propane cylinder) on page 24 (Spanish page 26) of their student manuals.</p> <p>Point out and ask the class to name components shown in Photo 2.</p>
C	Propane Cylinder Discussion (15 minutes)	
		<p>Stress the extreme potential danger of propane and the importance of safety.</p> <p>Remind the class that the video stressed the importance of matching the torch with the correct pressure regulator. Mismatching regulators and torches may create fire and explosion hazards.</p> <p>Remind the class that the video discussed two types of propane tanks that are used for roofing work:</p> <ul style="list-style-type: none"> • Vapor withdrawal • Liquid withdrawal <p>Ask the class which type is usually used for roofing torch work.</p> <p>Expected answer: Vapor withdrawal</p> <p>Direct the class to turn to Figure 4 and Figure 5 on pages 25-26 (Spanish pages 27 and 28) of their student manuals.</p> <p>Ask the class to state the key characteristics and differences between the two types of cylinders.</p> <p>Expected answers:</p> <p><u>Vapor withdrawal:</u></p> <ul style="list-style-type: none"> • Vapor collects above liquid. • This vapor is drawn off and burned off at the torch head. • Vapor tanks have a female valve fitting for hose connection.

Sec.	Notes and Materials	Directions and Discussion
		<p><u>Liquid withdrawal:</u></p> <ul style="list-style-type: none"> • A dip tube draws liquid propane from the bottom of the tank. • The liquid is carried to the torch head, where it is vaporized and burned. • Tanks manufactured after 1988 have a male valve. <p>Explain that the type of torch used with a liquid system differs from a torch used with a vapor system.</p> <p>Note: Some torches designed for liquid-withdrawal systems may be used with vapor-withdrawal systems. However, you cannot use vapor-withdrawal torches with a liquid system. Doing so will create a continuous uncontrolled fireball of burning liquid propane!</p> <p>Ask the class to describe the method shown in the video for testing for leaks between hoses and connections.</p> <p>Expected answer:</p> <ul style="list-style-type: none"> • Apply soapy water around connections. • If bubbles appear, tag the hose and remove it from service. <p>Write the following heading on a piece of flip chart paper: <u>Moving and Hoisting Cylinders.</u></p> <p>Ask students to state safety rules for moving and hoisting propane cylinders. If they are having trouble, direct them to pages 26-27 (Spanish pages 27 and 28) of their student manuals.</p> <p>Expected answers:</p> <ul style="list-style-type: none"> • Fasten cylinders in an upright position on a dolly or cart. • When moving a small cylinder without a cart, grip it by the protective collar. • Two people should move a large cylinder—one person grips the foot ring, and one grips the protective collar. • Never lay the tank on its side and roll it. • If hoisting a cylinder more than 30 inches, securely fasten it in an upright position in a hoisting cage. <p>Ask the students to state safety rules for storing propane cylinders. If they are having trouble, direct them to page 27 (Spanish page 29) of their student manuals.</p> <p>Expected answers: See the bulleted list on page 27 (Spanish page 29) of the student manual.</p>

Section

4

APPLICATION SAFETY

SECTION INTRODUCTION

OUTCOMES Upon completion of this section, participants will be able to:

1. Recognize hazardous areas
2. Describe safe torching techniques to use near hazardous areas

TIMING This section is divided into three parts:

- A. Video and discussion (35 minutes)
- B. Demonstration of assembling a roofing torch assembly (10 minutes)
- C. Hazards recognition exercise (45 minutes)

Total Unit Time: 90 minutes

MATERIALS

Video clip from CERTA Training Video
(running time 8 minutes 13 seconds on the English video and
9 minutes 46 seconds on the Spanish)



Student manuals





Roofing torch assembly

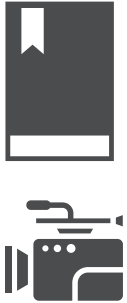
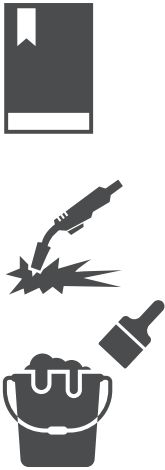

Soapy water and applicator

FACILITATION GUIDE

Sec.	Notes and Materials	Directions and Discussion
A	Video and Discussion (35 minutes)	
	 <div data-bbox="318 947 699 1136" style="border: 1px solid black; padding: 5px; margin-top: 10px;"> <p><i>Note: If you observe that people are not checking off the steps in their student manual, you can call out each step as it is being shown in the video.</i></p> </div>	<p>Tell students the torch-and-flop application method is the most effective work practice they can use. It is done to keep the open flame away from combustible areas.</p> <p>Direct the students to turn to page 33 (Spanish page 36) of their student manuals (instructions for torch and flop for field applications).</p> <p>Briefly review the steps for torch-and-flop application, beginning with the section titled Starting Field Membranes at Roof Edges or Walls. As you are reviewing the steps, be sure to ask whether everyone understands the steps.</p> <p>Continue this process with the section Ending Field Membranes at Roof Edges or Walls and the section Around Penetrations.</p> <p>Continue this process with the section on torch and flop for flashing applications: At Walls, Penetrations and Perimeter Edges.</p> <p>Direct the students to turn back to page 33 (Spanish page 36) of their student manuals (instructions for torch and flop for field applications).</p> <p>Explain you will be showing a video clip that will demonstrate all the steps that were just discussed.</p> <p>Tell the students to put a check mark in their student manuals by the steps as they see each step being demonstrated in the video.</p> <p>Stress the importance of students understanding these skills because they will be required to practice and demonstrate them in the hands-on portion of their training.</p> <p>Show Part 4 of the video.</p> <p>Ask students if they have any questions about the techniques they just saw demonstrated.</p>
B	Demonstration of Assembling a Roofing Torch Assembly (10 minutes)	
	 <p data-bbox="318 1881 678 1969"><i>Refer to the answer sheet on the next page to review the roofing torch assembly exercise.</i></p>	<p>Direct students to turn to page 44 (Spanish page 46) of their student manuals and find the page titled Assembling a Roofing Torch Assembly.</p> <p>Explain the page lists the steps for assembling a torch—but the steps are not in order. You will demonstrate each step as the class tells you, in order, which step you should take.</p> <p>Direct the students to fill in the correct step number on their handouts.</p> <p>Proceed with the assembly following the directions of the class as long as the directions are in the correct order.</p> <p>Direct the students to turn to page 30 (Spanish page 32) of their student manuals and refer to the section titled Lighting a Hand-held Torch.</p> <p>Tell them they will be required to follow these steps during the hands-on portion of the training.</p> <p>Ask for a volunteer to read Step 1, and continue this process for each step, clarifying the information, as necessary.</p>

C	Hazard Recognition Exercise (45 minutes)	
		<p>Divide the class into groups of three or four.</p> <p>Direct the students to turn to page 37 (Spanish page 38) of their student manuals.</p> <p>Explain the instructions for the exercise, and do Hazard No. 1 together as a class.</p> <p>Assign each group one or two of the hazards. Tell students they will have 20 minutes to discuss their assigned hazards.</p> <p>When 20 minutes have passed (or when most of the groups are finished—whichever comes first), ask one of the groups to provide their answers for the various hazards.</p> <p>Ask the rest of the students whether they agree, and give additional feedback and correction as necessary. Answers are not provided because the point is to engage in discussion, not to make sure to identify every possible answer.</p> <p>Continue until each hazard has been discussed.</p>

ASSEMBLING A ROOFING TORCH ASSEMBLY ANSWER SHEET

Step Number	Action
6	Open the propane cylinder valve fully while the regulator adjustment valve is still closed. Slowly open the regulator adjustment valve just enough to blow out any foreign matter. Close both valves.
4	Attach the regulator to the cylinder valve. Tighten the connection.
1	Inspect all equipment for damage.
8	Conduct a leak test.
3	Tightly close the cylinder valve handle and regulator adjustment valve using its knob or screw.
7	Assemble a roofing torch following its manufacturer’s instructions. Attach the other hose end to the roofing torch.
5	Attach the hose end connector to the regulator. Tighten the hose fitting snugly to the regulator outlet.
2	Inspect the cylinder valve for dirt or foreign substances. Clean it out with a clean rag or soft brush if necessary. Use compressed air to blow out any foreign material that may have accumulated during storage.

Section 5 POST-JOB REQUIREMENTS AND DUTIES

SECTION INTRODUCTION

OUTCOME Upon completion of this section, participants will be able to:

1. Explain the post-job fire watch and other duties

TIMING This section is divided into two parts:

- A. Fire-watch and post-job basics exercise (10 minutes)
- B. Video and discussion (20 minutes)

Total Unit Time: 30 minutes

MATERIALS



Video clip from CERTA training video
(running time 2 minutes 34 seconds on the English video and
3 minutes 17 seconds on the Spanish)







Student manuals



Flip chart and markers

FACILITATION GUIDE

Sec.	Notes and Materials	Directions and Discussion
A	Fire-watch and Post-job Basics Exercise (10 minutes)	
	 <p><i>Refer to the Ten Fire-watch and Post-job Basics Answer Sheet on the next page to review the exercise.</i></p>	<p>Direct students to turn to page 48 (Spanish page 50) of their student manuals and find the handout titled Ten Fire-watch and Post-job Basics.</p> <p>Tell the class that these 10 items are some of the most basic post-job duties and you will discuss post-job tasks in greater detail after reviewing this sheet and watching a video clip.</p> <p>Work through the handout together as a class, amplifying the statements for clarification as necessary.</p>
B	Video and Discussion (20 minutes)	
	  	<p>Show Part 5 of the video.</p> <p>Direct students to turn to page 46 (Spanish page 48) of their student manuals.</p> <p>Review this table with the class, focusing on what the evidence of fire is and how it is found.</p> <p>Ask the class to name the fire-watch and post-job duties, and record their answers on the flip chart.</p>

10 FIRE-WATCH AND POST-JOB BASICS

ANSWER SHEET

NOTE TO INSTRUCTOR: The CAPITALIZED words represent the pictures in the student handout. The **boldface** words represent the fill-in-the-blank words in the student handout.

In some cases, student answers may be slightly different from those indicated below. Answers can be considered correct if they have essentially the same meaning as the words shown below.

1. Most serious roof FIRES caused by torches happen **after** the crew has gone home.
2. Combustible materials can ignite during the day and not be noticed because they are SMOLDERING **under** the roof system.
3. The person who conducts a fire WATCH must be competent and have authority to take **action**.
4. The designated PERSON performs fire-watch duty throughout each **workday**.
5. In addition, a **two**-hour fire watch begins as soon as the last TORCH on the roof is extinguished. The fire watch may take longer, depending on conditions.
6. A competent person performing fire-watch duty must know where a building's FIRE ALARM is and know how to **operate** it.
7. He or she must also have authority by the BUILDING owner to **trigger** the alarm.
8. Interior inspections require easy access for viewing the underside of the roof deck or inspecting concealed attic areas. **After-hours** access for interior inspections is a KEY fire-watch requirement.
9. Post-job tasks include CHECKING that all cylinder **valves** are turned off.
10. Remove cylinders from the roof for overnight storage if you can. If not, gather all cylinders near the center of the roof away from **combustible** materials, penetrations, walls and roof edges. Secure cylinders upright in a group using steel wire, heavy CHAIN or a binder strap.

HANDS-ON TRAINING REQUIREMENTS, POLICIES AND PROCEDURES

SECTION INTRODUCTION

OUTCOMES By the completion of this hands-on unit, participants will be able to demonstrate the following:

1. Proper torch-lighting procedures.
2. Proper torch shut-down procedures.
3. Application of self-adhering base ply with a focus on ensuring sealed laps, using the flashing box mock-up.
4. Flashing torch-and-flop application using the flashing box mock-up.
5. Flashing direct torching application using the flashing box mock-up and a detail application-size (105k Btu or less) torch.
6. Proper starting of field membrane rolls at roof edges or walls.
7. Torch-and-flop method for going around a pipe penetration and a drain.
8. Torch-and-flop method for installing field sheet over the drain penetration.
9. Torch-and-flop method for ending field membranes at roof edges or walls.
10. Ability to evaluate and rate others' torching behaviors.

TIMING

This section is divided into four parts:

- A. Hands-on workstation setup
- B. Instructor demonstrations
- C. Participant exercises
- D. Program wrap-up

Total Unit Time: 180 minutes (3 hours)

See detailed table for time schedule.

MATERIALS



Scheduled materials and equipment checklists









Torching equipment (from checklist), circular saw, hammer, carpenter's square, screw gun

Event	Hands-on Exercises Schedule	
8	Hands-on Instruction: Instructor Demonstrates Torch Lighting	5 minutes
	8-1: Lighting Procedures	2 minutes
	8-2: Shutting Down Torch	3 minutes
9	Hands-on Instruction: Instructor Demonstrates Applying Self-adhering Base Ply	5 minutes
10	Hands-on Instruction: Instructor Demonstrates Flashing Torch and Flop	10 minutes
11	Hands-on Instruction: Instructor Demonstrates Flashing Direct Torching	10 minutes
12	Hands-on Instruction: Instructor Demonstrates Field Torch-and-flop Applications	20 minutes
	12-1: Starting Rolls at Roof Edges or Walls	5 minutes
	12-2: Interior Roof Drain	6 minutes
	12-3: Penetration	5 minutes
	12-4: Finishing Rolls at Roof Edges or Walls	4 minutes
13	Hands-on Instruction: Participant Torch Exercise Rotation and Evaluation	120 minutes
	13-1, Station 1 and 2: Flashing Torch and Flop	60 minutes each team
	13-2, Station 3 and 4: Field Applications Torch and Flop	60 minutes each team
14	Program Wrap-up	10 minutes
	Total	180 minutes (3 hours)

FACILITATION GUIDE

A	Hands-on Workstation Setup (Prepare before conducting training session.)	
<div style="border: 1px solid black; padding: 10px; width: fit-content; margin: 0 auto;"> <p style="text-align: center;">Materials and Equipment Lists</p> </div> <div style="display: flex; justify-content: center; gap: 10px; margin-top: 10px;"> <div style="width: 20px; height: 15px; background-color: #ccc; border: 1px solid #000;"></div> <div style="width: 20px; height: 15px; background-color: #ccc; border: 1px solid #000;"></div> <div style="width: 20px; height: 15px; background-color: #ccc; border: 1px solid #000;"></div> <div style="width: 20px; height: 15px; background-color: #ccc; border: 1px solid #000;"></div> </div>	<p>Identify the training location, and be sure it will meet all the safety requirements (e.g., ventilation, fire protection).</p> <p>Gather all materials, tools and equipment together for the training session. Use the tables provided on pages 28 and 29 of this section.</p> <p>Decide on mock-up locations, taking into consideration all safety requirements. Weather permitting, always try to conduct hands-on exercises outdoors, but have a backup location identified in case the weather does not cooperate.</p> <p>Build mock-ups: You will provide four fully equipped mock-up stations for students to perform hands-on training exercises. Refer to mock-up drawings on pages 29 to 32 of this section.</p>	

		<p>Basic roof deck mock-ups are constructed using 2x3 or 2x4 dimensional lumber, ½-inch plywood and fiberglass mat-faced gypsum core panel. Flashing boxes are constructed of 2- by 12-inch or 2- by 14-inch dimensional lumber. Refer to pages 29 to 32 of this instructors guide for details.</p> <p>Roll out heavy fiberglass base sheets to protect concrete floors. Extend the sheets a minimum of 3 feet beyond each side of where the roof deck and flashing box mock-ups will be set after the sheets are laid. Place propane cylinders a minimum of 10 feet from each workstation. Place two 4A60BC fire extinguishers centrally located near the mock-up stations.</p> <p>Prepare all torching equipment. Assemble torch assemblies, and test them for leaks. Or, if you decide to extend the shop time, you may have participants do the assembling and leak testing under your supervision.</p> <p>Distribute all roofing materials at each workstation. Pre-cut enough base plies and flashing strips before a session. There will only be time for participants to do this as part of their exercise if you extend the time. Cutting flashing membranes is not a skill this program addresses.</p>
<p>B Instructor Conducts Hands-on Exercise Demonstrations Total 50 minutes</p> <p>Have students take turns reading aloud to you the step-by-step instructions found in their evaluation checklist on pages 57 and 58 (Spanish pages 59 and 60) of the student manual during your demonstration.</p>		
<p>8</p>		<p><i>Event 8 (5 minutes)</i></p> <p>8-1, 2 minutes: Demonstrate proper torch-lighting procedures.</p> <p>8-2, 3 minutes: Demonstrate proper torch shut-down procedures.</p>
<p>9</p>		<p><i>Event 9 (5 minutes) (stations 1 or 2)</i></p> <p>Demonstrate proper application of self-adhering base ply with a focus on ensuring sealed laps, using the flashing box mock-up.</p>
<p>10</p>		<p><i>Event 10 (10 minutes) (stations 1 or 2)</i></p> <p>Demonstrate flashing torch-and-flop application using the flashing box mock-up.</p>
<p>11</p>		<p><i>Event 11 (10 minutes) (stations 1 or 2)</i></p> <p>Demonstrate proper flashing direct torching application using the flashing box mock-up and a detail application-size (105k Btu or less) torch.</p>

<p>12</p>		<p><i>Event 12 (20 minutes) (stations 3 or 4)</i></p> <p>12-1: Demonstrate proper starting of field membrane rolls at roof edges or walls.</p> <p>12-2:</p> <ul style="list-style-type: none"> a. Demonstrate the proper torch-and-flop method for going around a pipe penetration. b. Demonstrate the proper torch-and-flop method for installing a target flashing sheet around an interior drain. <p>12-3: Demonstrate the proper torch-and-flop method for installing field sheet over the drain penetration.</p> <p>12-4: Demonstrate the proper torch-and-flop method for ending field membranes at roof edges or walls.</p>
<p>C Supervise and Evaluate Participants’ Performance of Hands-on Exercises Total 130 minutes (2 hours, 10 minutes)</p>		
<p>13</p>	 <div style="border: 1px solid black; padding: 10px; margin-top: 20px; text-align: center;"> <p>Hands-on Exercise Evaluation Forms</p> </div>	<p>Count off participants into groups 1 through 4. The result will be four groups of five people for a 20-person session.</p> <p>Tell participants to turn to pages 57 and 58 (Spanish pages 59 and 60) of the Appendix of their student manuals and remove the Hands-on Performance Evaluation Form. Tell participants to write their names at the top of the form as the torch operator.</p> <p>Explain to participants what constitutes failure of the hands-on part of this course. They are being evaluated by their peers on how well they perform the prescribed torching operation following the listed criteria on the evaluation form. There are 60 individual items on the evaluation form.</p> <p>Explain Reasons for Failure.</p> <p>Reasons for automatic failure include:</p> <ul style="list-style-type: none"> • Smoking within 50 feet of a propane cylinder • Scoring a 1 on any one of the seven “never touches the _____ with a flame” items • Injuring himself or herself or another participant, whether intentional or not • Engaging in unruly behavior or misconduct as determined by the authorized instructor <p>A participant also fails this hands-on evaluation if he or she receives 18 or more 1 scores on the total evaluation.</p> <p>Position each group at one of the four workstations. Field mock-ups will use field-sized torch assemblies, and flashing box mock-ups will use detail-sized torch assemblies.</p>

<p>13-1</p>	<p>Tell the groups they have 60 minutes to complete each group exercise.</p> <p>Rotate participants from task to task until each group member has performed all tasks related to the torching exercise.</p> <p>Advise students to evaluate one another in a positive and constructive manner, providing feedback to the torch operator <i>based on the criteria set forth in the step-by-step instructions they reviewed on pages 30 through 35 (Spanish pages 32 to 38) of their student manuals</i>. Remind them they should not be injecting personal opinions about ways they were taught or shortcuts they may know nor should they suggest their experience is a “better” way to do a task. Reinforce the feedback needs to be objective, constructive and positive in tone.</p> <p>Monitor each group’s evaluation feedback to ensure positive, constructive comments are being given. You may also add your own feedback.</p> <p>Explain to evaluators they need to agree on a performance grade for the torch operator, again keeping it objective, and have evaluators write the operator’s grade in the space provided on his or her evaluation form. If an operator performs poorly, discuss with the group and assist the operator as time allows. The objective here is to teach operators safe torching habits.</p> <p>Keep a close eye on all exercises, and maintain order. Do not allow horseplay or other inappropriate behavior.</p> <div style="border: 1px solid black; padding: 10px; text-align: center;"> <p>Station 1 and 2: Flashing exercise on one side of a flashing box— 60 minutes simultaneous with event 13-2</p> </div> <p>Participant 1—may choose to either install a self-adhered base ply with sealed laps and direct torch a flashing using only a detail torch or may choose to perform the flashing torch-and-flop application by following the step-by-step instructions on the evaluation form. This will include properly lighting and shutting down a torch assembly.</p> <p>Participant 2—performs fire-watch duty while others are torching. He or she is to perform no other duties during the fire watch. This person has the authority to stop an exercise if he or she observes a fire risk.</p> <p>Participants 3, 4 and 5—observe that participant 1 is performing the torching sequence properly following the step-by-step instructions provided on the evaluation form. This includes never allowing a flame to touch a flashing box.</p> <p>At the end of the first 60-minute exercise, groups exchange places with workstations 3 and 4 to begin the second round of simultaneous exercises.</p>
-------------	--

<p>13-2</p>		<div style="border: 1px solid black; padding: 10px; text-align: center;"> <p>Stations 3 and 4: Field Mock-up Exercise for starting and ending rolls and installing around penetrations using flat field mock-ups—60-minute exercise simultaneous with 13-1</p> </div> <p>Participant 1—performs each of the torch-and-flop field application tasks following the step-by-step instructions provided on the evaluation forms. These tasks include:</p> <ul style="list-style-type: none"> • Starting rolls at a roof edge or wall • Installing a target sheet over the roof drain area • Installing the field membrane over the roof drain area • Installing the field membrane around a pipe penetration • Ending the roll at a roof edge • Properly lighting and shutting down a torch assembly <p>Participant 2—same fire-watch duty as described in 13-1.</p> <p>Participants 3, 4 and 5—conduct evaluations as described in 13-1.</p>
<p>D</p>	<p>Program Wrap-up (10 minutes)</p>	
<p>14</p>	<div style="border: 2px solid black; padding: 10px; width: fit-content; margin: auto;"> <p>Program Evaluation Forms</p> </div>	<p>Instruct participants to fill out the program evaluation form on pages 59 and 60 (Spanish pages 59 and 60) in the Appendix of their student manuals. Encourage participants to complete these forms and mail them to NRCA.</p> <p>Confirm you have all the personal information you will need to complete your roster sheet.</p> <p>Inform participants you will distribute their certification cards as soon as you receive them. Remember the tasks you need to do: Grade their exams; tabulate their torching performance evaluation forms; submit the session roster; and wait two to four weeks for NRCA to process and mail the cards to you for distribution.</p> <p>Thank everyone for participating.</p>

Equipment and Materials Requirements

Hands-on Training Mock-up Construction Materials

√	Quantity	Unit	Description
			Mock-up Construction
	192	Square feet	¼-inch fiberglass mat-faced gypsum core panel
	3	Sheets	4-foot-by-8-foot-by-½-inch CDX plywood
	15	Each	2x4 dimensional lumber by 45-inch length
	6	Each	2x4 dimensional lumber by 8-foot length
	2	Each	2- by 12- or 14-inch construction-grade dimensional lumber by 12-foot length
	150	Each	1¼-inch general-purpose screws
	100	Each	16 penny nails
	50	Each	¾-inch tin-capped roofing nails
	2	Each	9-inch metal pie tins, large coffee cans or galvanized tall cone flashing
	2	Each	4-inch-diameter steel pipe by 10- or 12-inch length
	2	Each	½-inch plywood circles cut to 4-inch O.D. pipe size
	2	Each	12-inch wood screws

Hands-on Training Roofing Materials

			Roofing Materials: 20 Participants
	1	Roll	Heavy fiberglass base sheet (#75-type)
	1	Roll	Self-adhering polymer-modified base sheet
	9	Rolls	APP polymer-modified bitumen membrane—smooth or granulated
	8	Each	Wood fiber cant strips—3-foot lengths (optional)
	1	Box	Arrow T-50 staples for staple gun (or equivalent)
	10	Each	Hooked blades for roofing knives
	1	Bottle	Liquid soap (for leak-detecting solution)

Hands-on Training Roofing Equipment

√	Quantity	Unit	Description
	4	Each	20-pound vapor liquid petroleum (LP) gas cylinders
	4	Each	Pressure regulators
	4	Each	Pressure gauges
	4	Each	25-foot UL-listed hoses
	4	Sets	Swivel-type connectors for torch assemblies

√	Quantity	Unit	Description
	2	Each	Propane roofing torches—detail application size not to exceed 105K Btu
	2	Each	Propane roofing torches—field application size
	4	Each	Spark-type igniters
	2	Each	Adjustable wrench
	1	Each	Flat-blade screwdriver (for changing knife blades)
	4	Each	Utility-type roofing knives
	1	Each	Arrow T-50 staple gun (or equivalent)
	4	Each	Large round-nosed trowels
	2	Each	4A60BC fire extinguishers, fully charged, with updated inspection tags and intact plastic seals
	1	Each	Comprehensive first-aid kit
	1	Each	Clean plastic 5-gallon pail (for water)
	1	Each	Small plastic squirt bottle
	5	Each	ANSI Z-97 goggles (eye protection)
	5	Pair	Leather-palmed heavy work gloves (hand protection)

Mock-up Design, Construction and Setup

The drawings below represent mock-ups you will need to construct before conducting the hands-on training portion of this program.

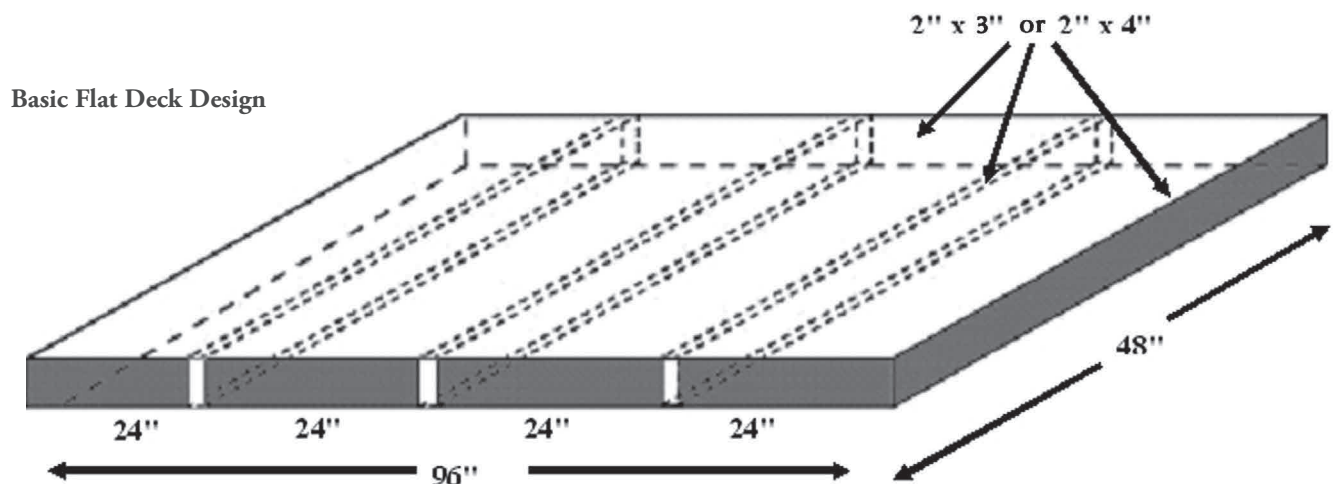

Construct basic flat deck using 2x3 or 2x4 dimensional lumber secured with 16d nails as shown here. Install one layer ½-inch minimum CDX plywood to deck over the 2x4 frame, secured 8 inches on center with 1¼-inch general-purpose screws. Install two layers of ¼-inch fiberglass mat-faced gypsum core panel secured with ¾-inch tin-capped nails over the plywood. You will need to construct three basic flat deck mock-ups to conduct the hands-on training exercise.

Simulated Roof Drain

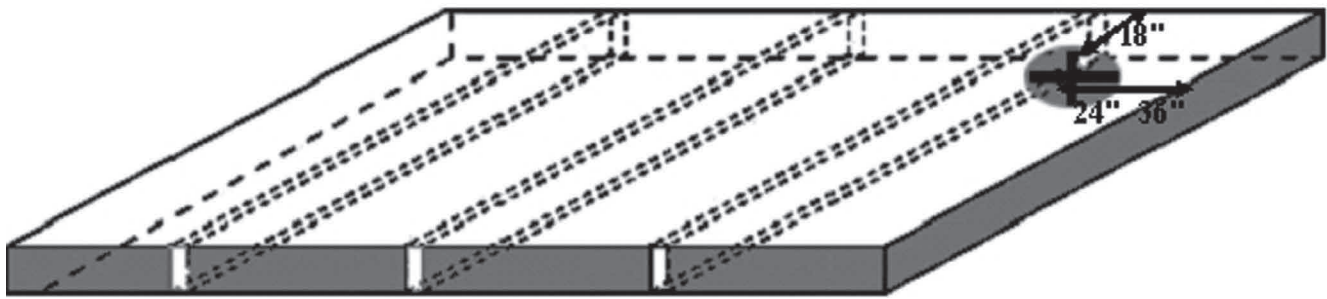

Cut a hole 18 inches from one side and 18 to 24 inches from one end in two of the three basic flat deck mock-ups. Use a 9-inch metal pie tin, a large coffee can or an inverted galvanized steel tall cone flashing cut to height to simulate a roof drain opening. Secure the simulated roof drain in the hole.

Basic Flashing Box Mock-up

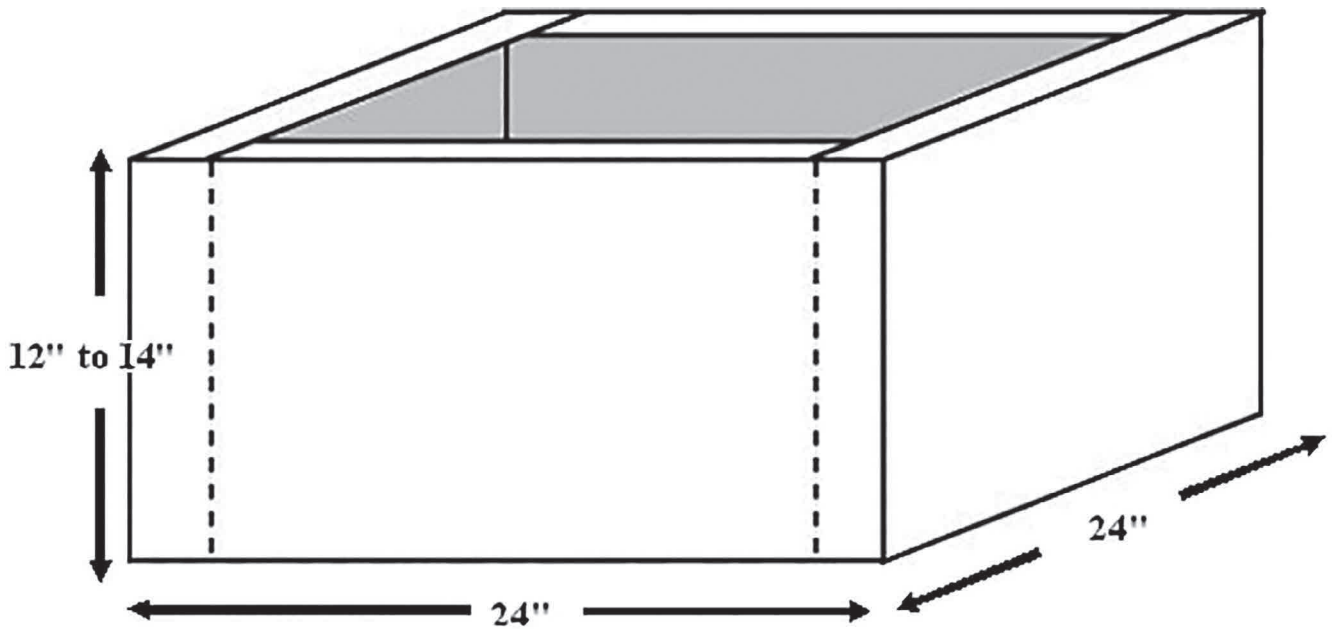

Construct basic flashing box mock-up using four pieces of 2- by 12- or 14-inch dimensional lumber nailed together using 16d nails. Add new cant strips for each training session.

Basic Pipe Penetration Mock-up

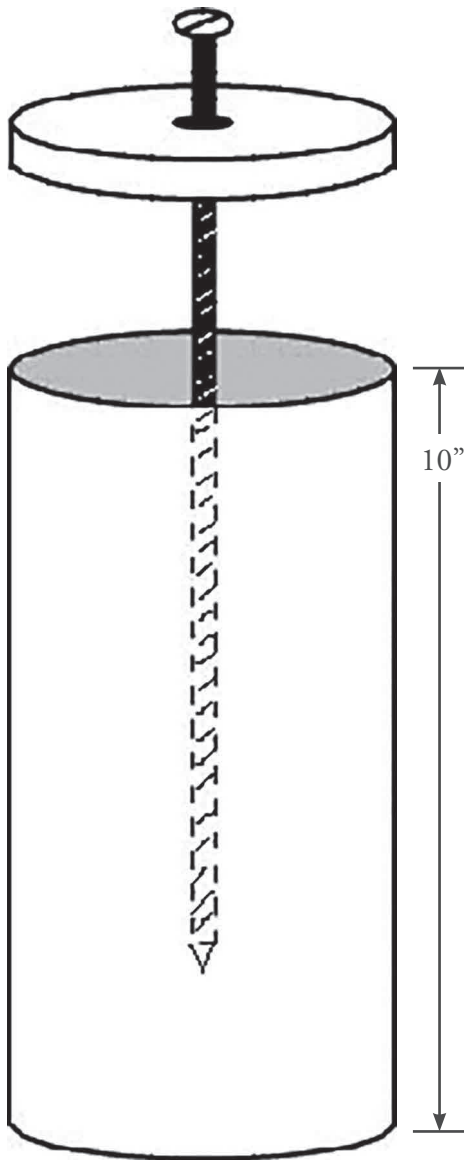

Construct basic pipe penetration mock-up using a minimum 10-inch length of 3- or 4-inch pipe; a circular plywood disk cut to size of the outer pipe diameter; and a screw 2 inches longer than the pipe length. Drill a hole near the center of the plywood disk to accept the screw. Secure the basic pipe penetration mock-up at the opposite end of the basic deck mock-up approximately 18 inches from one side and 24 inches from the end. The basic pipe mock-up can easily be removed for storage.

Mock-up Station Layout Plan

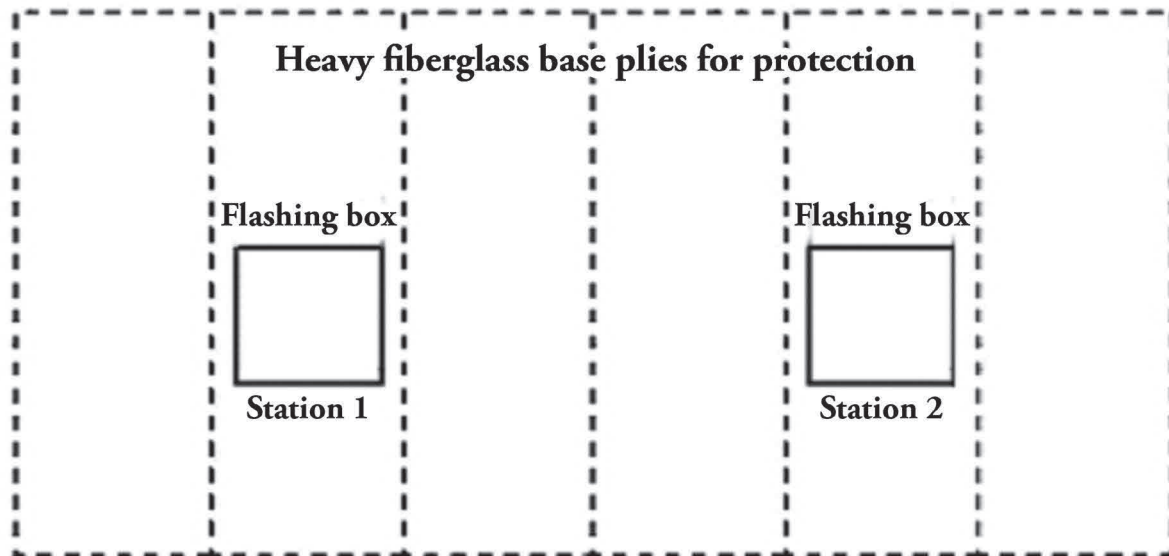
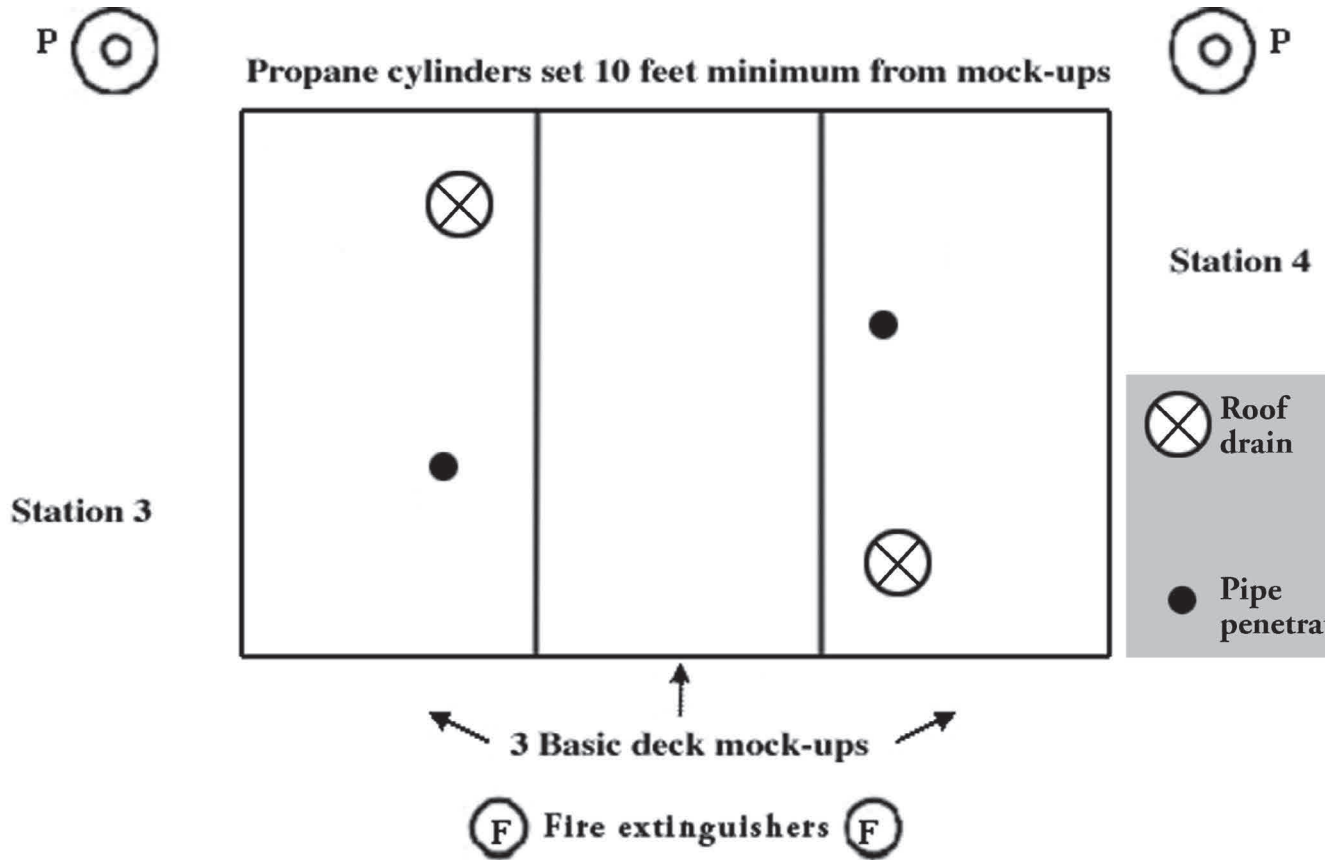

Lay the three basic deck mock-ups side by side with the two drain openings at opposite ends. Cover over entire basic deck mock-up layout using heavy fiberglass base ply sheet stapled into place. Lay fiberglass base ply ground protection for Stations 1 and 2 flashing box areas. Set flashing boxes approximately 8 to 10 feet apart. Install cant strips around flashing boxes. Cover flashing boxes and cant strip using heavy fiberglass base ply sheets stapled securely in place. Set two 4A60BC fire extinguishers between the workstations. Set a 20-pound propane tank a minimum of 10 feet away from each workstation.